

electriciQ

USER MANUAL

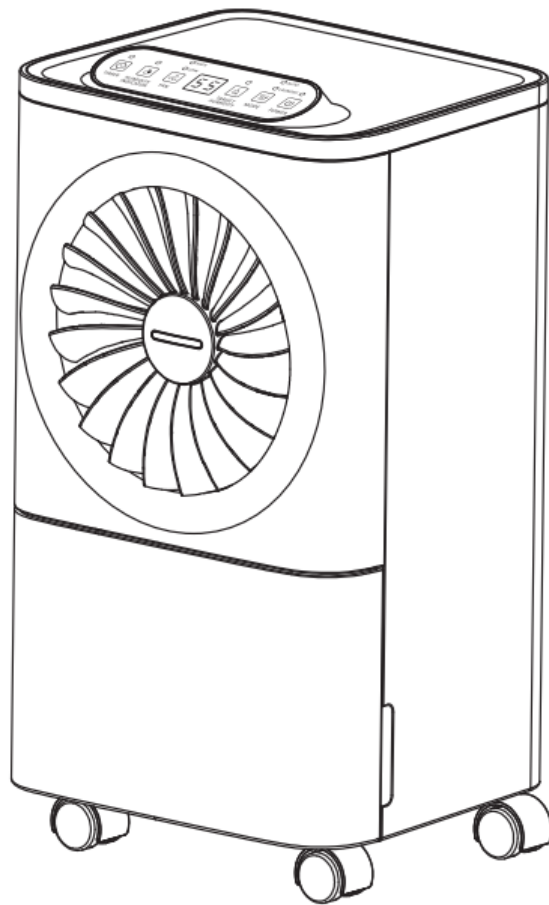

CD10L-V5 **10 LITRE COMPRESSOR DEHUMIDIFIER**

Thank you for choosing electriciQ.

Please read this user manual before using this innovative dehumidifier and keep it safe for future reference

Visit our page www.electriQ.co.uk for our entire range of Intelligent Electricals

SETTLING IN OK?

We hope this has been helpful to you.

We would love to see how you're getting on with your new purchase, so please share any snaps you have on the platform of your choice below.

Our community awaits your uploads - Snap, tag and hashtag away!



@electriQUK
#electriQUK

WE'RE HERE TO HELP

Should you have any problems or questions with your purchase, please contact a member of our customer service team.

☎ 0330 390 3061

✉ support@electriQ.co.uk

Mon-Fri | 9am to 5pm

Unit J6, Lowfields Business Park,
Lowfields Way, Elland
West Yorkshire, HX5 9DA

CONTENTS

SAFETY INSTRUCTIONS	3
VISUAL SAFETY GUIDE	5
FEATURES	5
INSTALLATION	6
POSITIONING THE DEHUMIDIFIER	6
PARTS	7
CONTROL PANEL	8
WATER DRAINAGE	9
CARE AND MAINTENANCE	11
TROUBLESHOOTING	12
TECHNICAL DATA	13
SUPPORT	14

SAFETY INSTRUCTIONS

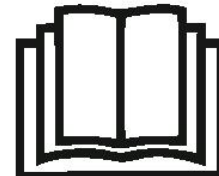

IMPORTANT

- Carefully read the instructions before operating the unit
- This appliance is for indoor use only and intended for use in a domestic environment only. Any other use is not recommended by the manufacturer and may cause fire, electrical shocks or other injury to user or property.
- Rating: This unit must be only connected to a 220-240 V / 50 Hz earthed outlet.
- Installation must be in accordance with regulations of the country where the unit is used.
- If you are in any doubt about the suitability of your electrical supply have it checked and if necessary, modified by a qualified electrician.
- This dehumidifier has been tested and is safe to use. However, as with any electrical appliance - use it with care.
- Disconnect the power before dismantling, assembling or cleaning.
- Avoid touching any moving parts within the appliance.
- Never insert fingers, pencils or any other objects though the guard
- This appliance is not intended for use by persons (including children) with reduced physical, sensory or mental capabilities. It is also not intended for use by those with a lack of experience and knowledge, unless they have been given supervision or instruction concerning the use of the appliance by a person responsible for their safety.
- Do not leave children unsupervised with this appliance.
- Do not clean the unit by spraying it or immersing it in water.
- Never connect the unit to an electrical outlet using an extension cord. If a power outlet is not available, one should be installed by a qualified electrician.
- Never operate this appliance if the cord, power adapter or plug is damaged. Ensure the power cord is not stretched or exposed to sharp objects/edges.
- A damaged power supply cord should be replaced by the manufacturer or a qualified electrician in order to avoid a hazard.
- Any service other than regular cleaning or filter replacement should be performed by an authorised service representative. Failure to comply could result in a voided warranty.
- Do not use the appliance for any purpose other than its intended use.
- Do not tilt the unit while in use. The unit is design to work only in vertical position.
- This dehumidifier must always be stored and transported upright, otherwise irreparable damage may be caused to the compressor; if in doubt we suggest waiting at least 24 hours before starting the unit.
- Avoid restarting the dehumidifier unless 5 minutes have passed since being turned off. This prevents damage to the compressor.
- Never use the plug as a switch to start or turn off the dehumidifier. Use the provided Power button located on the control panel.
- Always place the unit on a dry and stable surface.
- The appliance should not be installed in laundry or wet rooms where the humidity is higher than 85% RH
- Do not dry laundry above the unit to prevent water entering the dehumidifier. Place the laundry at least 1 meter away from your dehumidifier.

- Before moving the appliance the water tank should be emptied.
- When carrying the unit, it should be kept upright and sufficiently supported from its base.
- The appliance must be placed in a room without sources of ignition (for example: open flames, an operating gas appliance or an operating electric heater).
- R290 refrigerant gas complies with European environmental directives.
- R290 has a low GWP (Global Warming Potential) of 3.
- The CD10L contains about 50g of R290 refrigerant gas.
- Do not use or store the appliance in an unventilated space with an area smaller than 4m² per unit.
- If the appliance is installed, used or stored in an unventilated room, the room must be such as to prevent stagnation of possible leaks of refrigerant gas as there could be a danger of fire or explosion should the refrigerant come into contact with electric heaters, stoves or other sources of ignition.
- Refrigerant gas may be odourless.
- Do not use the product and contact the retailer for advice, if damage has occurred to the unit which may have compromised the refrigerant system.
- Any repairs or maintenance must only be carried out on the unit by a suitably qualified engineer. Before opening and servicing the unit the authorized engineer must be in possession of a copy of the manufacturer's service manual and must follow the safety information contained within it to ensure all hazards are minimized.
- The refrigerant system should not be perforated or punctured.
- Do not place the unit next to heat sources (e.g. electrical fires, fireplaces, etc.)
- Avoid mishandling the dehumidifier. Dropping, throwing the unit can cause damage to its internals and increases the risks of operating it.
- Do not store or use gasoline, petrol, paint, solvents or other flammable vapours or liquids in the vicinity of this dehumidifier or any other appliance.
- This dehumidifier must not be used in spaces where there is a high concentration of gases, solvent or other volatile organic compounds; in very dusty environments; in any domestic, commercial or industrial environment where the air composition is flammable.

ENERGY SAVING AND UNIT SAFETY PROTECTION TIPS

- Do not cover or restrict the airflow from the outlet or inlet grills. Do not operate and follow troubleshoot procedure if the self-opening louvers do not open on power on.
- For maximum performance the minimum distance from a wall or objects should be 20 cm
- Keep the filters or grills of the unit clean. Under normal conditions, filters or grills should only need cleaning once every three weeks (approximately).
- Since the filters remove airborne particles, more frequent cleaning maybe necessary, depending on the air quality. Vacuum both mesh and optional carbon filters and wash the mesh filters with hot soapy water and dry them before placing them back in the unit.

QUICK VISUAL SAFETY GUIDE ON WHERE OR WHEN NOT TO USE YOUR DEHUMIDIFIER

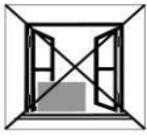

Exposed to the weather outdoors



Near water



If the power cable wires are frayed or cut



Where small children may be left unattended

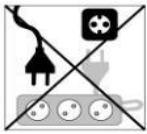

If an extension lead may become overloaded



Where the power cable may be damaged



On a slope or uneven surface



Where there is risk of fire or close to a naked flame

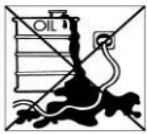

Where it may be damaged by chemicals



Where there is a risk or interference by foreign objects



This product is not made for DIY repair



If there is a risk of water falling on the unit

FEATURES

Your dehumidifier belongs to the electriQ dehumidifier range.

1. Easy to use controls
2. Great for up to 3 bed houses
3. Lightweight and portable
4. Cost effective way to combat mould, condensation and damp
5. Laundry mode - dries laundry more efficiently than a tumble dryer
6. Designed to complement any modern space
7. Intelligent CPU controlled digital humidistat with 35-80% RH and room humidity display
8. 24 hours stop timer
9. Easy to remove front tank.
10. Tank operation or permanent drainage option
11. Tank full alarm & auto-stop function
12. Auto restart following power cut.

INSTALLATION

Remove any water from within the water tank before starting the unit. In order to save energy do not open windows or doors while the unit is running. Place the unit on a hard / flat surface. On first use run the unit continuously for 24 hrs.

TO REDUCE NOISE LEVELS:

Place a piece of carpet or a rubber mat under the unit to reduce any vibrations while the unit is running.

The CD10L dehumidifier uses compressor technology to extract water from the environment. Compressor dehumidifiers are ideal for normal domestic or office environments which are heated during the winter months and maintain a temperature above 12-15°C.

Your dehumidifier is lightweight and easy to move. It is designed to extract unwanted humidity while saving money due to its power saving logic. The unit features an intelligent humidistat where the desired relative humidity can be adjusted in increments of 5% between 35 and 80% ensuring your room is not dried too much and power is not wasted.

POSITIONING THE DEHUMIDIFIER

A badly positioned dehumidifier will have little effect. In positioning the dehumidifier please ensure circulation of air in not restricted around the unit.

Allow at least 20 cm space around the unit. This dehumidifier is designed only for indoor residential or small office applications and any commercial or industrial use will invalidate the warranty.

Use in an enclosed area for maximum efficiency. Close all doors, windows to create an effective operating environment. Do not use outdoors.

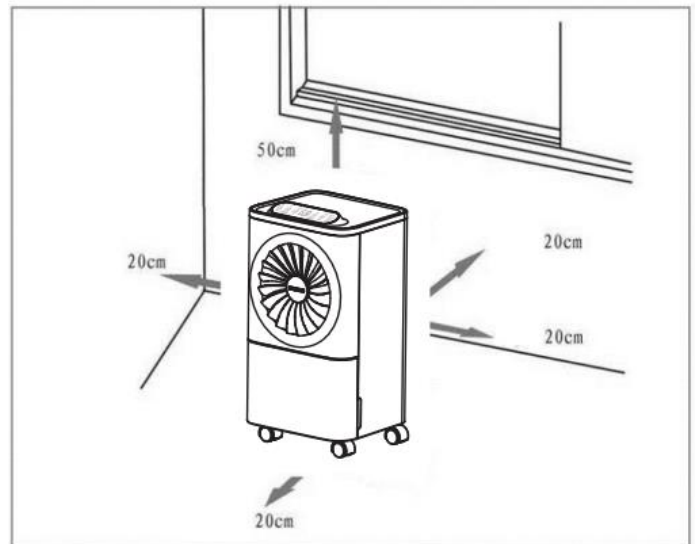

Your electriQ dehumidifier will begin to protect your space from the harmful effects of excessive moisture as soon as it is turned on. Excess moisture is dispersed throughout your home. For this reason, the dehumidifier should be positioned in a central and clear location so that it can draw this moist air towards it from all over the home. A warm hallway or landing is an excellent position for your dehumidifier. If possible, leave interior doors ajar to allow air circulation.

Alternatively, if you have a serious problem in one area you can begin by positioning the dehumidifier there and moving it to a more central location at a later date. For the most effective use, run your dehumidifier with external doors and windows kept closed. Please note the unit should not be placed directly against a radiator or other heat source.

Before moving the appliance the water tank should be emptied. When carrying the unit, it should be kept upright and sufficiently supported from its base.

When positioning your electriQ dehumidifier, ensure that it is placed clear of any obstacle that may limit the air movement. Place the dehumidifier on a flat dry surface.

PARTS

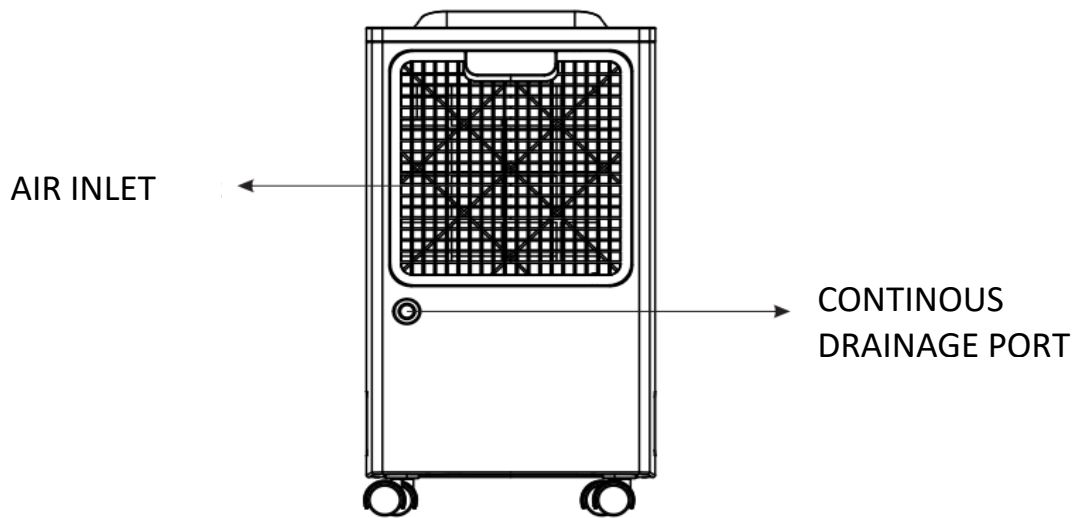
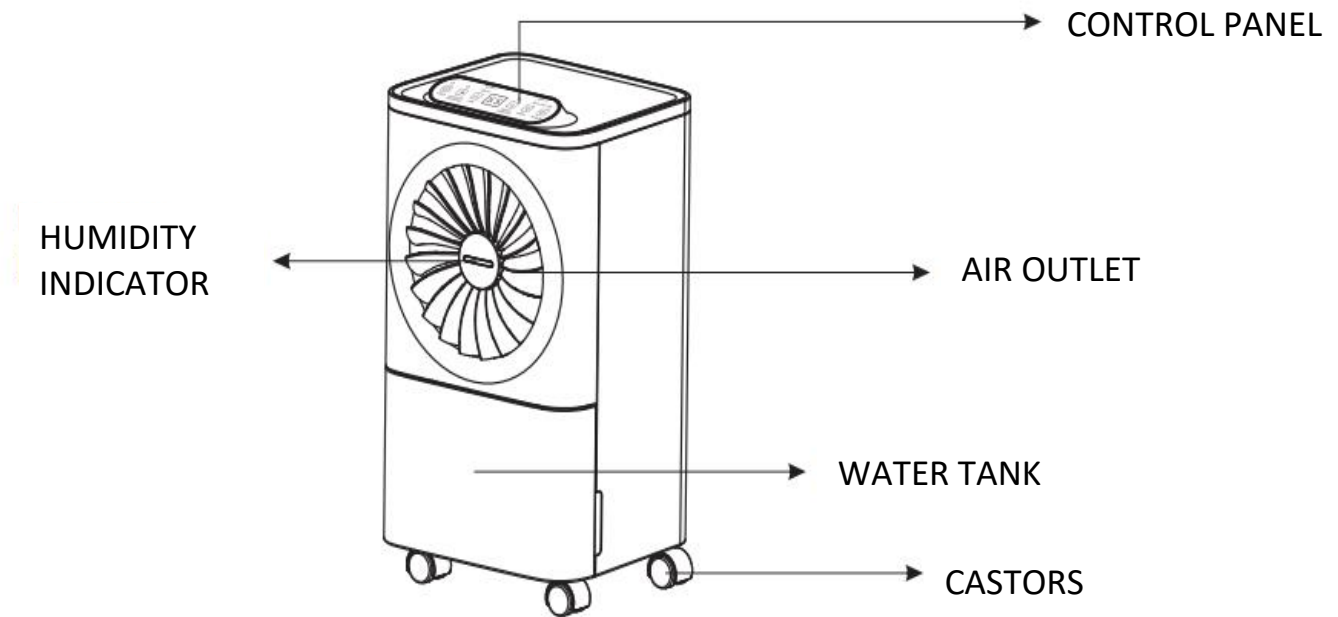

OPTIONAL

To fit the filters, remove the filter frame from the air inlet, and place them flush within the air inlet. If using both the Carbon and HEPA filters in combination, the Carbon filter should be inserted first.

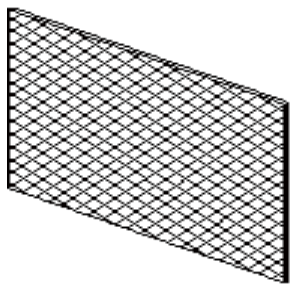

CARBON FILTER

Replacement Activated carbon filters are available from the retailer under reference: ACFIL-CD10L-V5







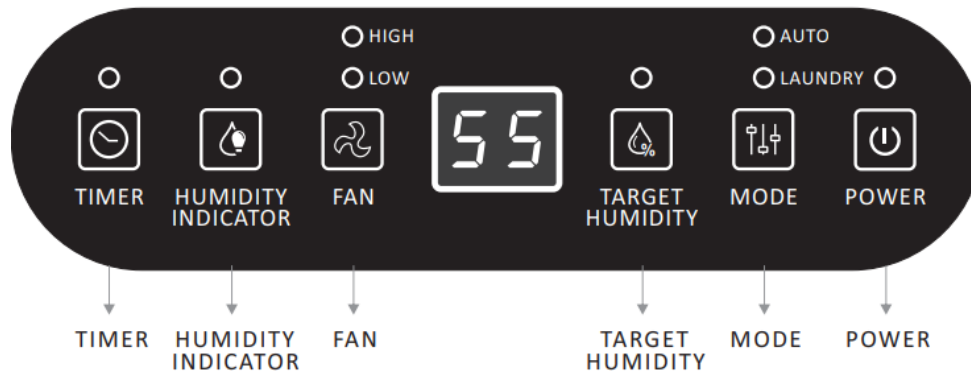

HEPA FILTER

Replacement HEPA filters are available from the retailer under reference:

HEPA-CD10L-V5

CONTROL PANEL



	<p>POWER Turn the appliance on/off</p>
	<p>MODE Select the operating mode of the unit between Laundry and Auto. The fan will operate continuously to monitor the humidity. AUTO MODE: The unit will start dehumidifying when the humidity increases to 5% above the desired humidity and will stop when the humidity drops to 5% below the desired humidity. The default desired humidity is 55% RH LAUNDRY MODE: The unit will dehumidify continuously unless the water tank is full or the unit is going through its defrost cycle. This is ideal for drying clothes.</p>
	<p>TARGET HUMIDITY During Auto Mode press to adjust the desired humidity of the room. This can be changed between 35% and 80% in 5% increments. The unit will initially default to 55% RH.</p>
	<p>FAN SPEED Press to change between HIGH and LOW fan speeds.</p>
	<p>HUMIDITY INDICATOR When the appliance is started, the indicator light will turn on automatically. The indicator light colour will change according to the humidity. RED: High humidity $RH \geq 70\%$ ORANGE: Above ideal humidity $70\% > RH \geq 60\%$ GREEN: Ideal humidity $RH < 60\%$ Press the HUMIDITY INDICATOR button to turn the humidity display on or off. NOTE: It can take around 2 minutes after the humidity has changed for the colour indicator to change, for example, if the humidity drops to 55%, it may take 2 minutes for the indicator to change to green.</p>
	<p>TIMER Press the TIMER button to program the timer. When the timer is activated the "TIMER" light will be illuminated. Before programming the timer, ensure the timer function has not been activated (the light must be off). The following timer programs are available. DELAYED POWER-OFF FUNCTION: While the appliance is running with the desired settings, repeatedly press the TIMER button to set in how many hours time you require the unit to stop (0~24 hours).</p>

DISPLAY



Shows the desired humidity when the TARGET HUMIDITY button is pressed

Shows the timer duration when the TIMER button is pressed

NOTES

- If a permanent drainage pipe is fitted the unit will not stop operating. Setting the desired humidity to around 35% is good for laundry mode, a quick drying boost, or in emergencies. It is not recommended for long normal operation in a domestic or office environment.
- To allow more moisture in the air, set a higher desired humidity (e.g. 60-70%).
- We recommend setting the desired humidity to 50-55%. This is great for domestic operation and dry storage
- Setting the humidity to 60% is great for personal comfort and applications where 50% RH is considered too dry
- Setting the humidity to 70% is ideal for unoccupied properties or where an economical run is needed without the need to reduce the humidity further.

OTHER FEATURES AND INDICATORS

TANK FULL INDICATION

When the water tank is full, removed or incorrectly inserted the unit will stop dehumidifying, E2 will display and the unit will bleep. Empty the tank and reinsert it correctly to resume operation.

AUTO DEFROST

When frost builds up on the evaporator coils, the compressor will cycle off and the unit will go in to defrost mode. Following completion of the defrost mode, the unit will return to the previously operating settings.

- When the unit is running in a room with a temperature between 0°C and 12°C, it will enter defrost mode for 8 minutes roughly every 30minutes.
- When the unit is running in a room with a temperature between 12°C and 16°C, it will enter defrost mode for 5 minutes roughly every 60minutes.
- When the unit is running in a room with a temperature between 16°C and 20°C, it will enter defrost mode for 5 minutes roughly every 90minutes.

AUTO MODE

- When the humidity of the room is 5% lower than the desired humidity the compressor will turn off automatically but the fan will continue to operate to ensure that the air within the room is not stale. The unit will use only a minimal amount of energy in fan mode.
- When the humidity of the room is 5% higher than the desired humidity the compressor will restart after a 3 minutes delay to protect the compressor.

POWER

After the unit has stopped, to protect the compressor it is not recommended to resume operation for at least 5 minutes. Operation can resume after this period lapses. When the unit is restarted there is a 3 minutes delay before compressor will start.

WATER DRAINAGE

When the water tank is full, the unit will stop automatically. When this happens the unit will display E2 on the control panel.

NOTE: Only empty the water tank when it is full or before moving or storing the unit.

There are two ways to dispense collected water.

USE THE TANK

When the tank is full, the unit will automatically stop running, and E2 will display on the control panel.

Slowly pull out the tank. Empty the water tank and reinsert it into the dehumidifier. The tank must be in place and securely seated for the dehumidifier to operate again. The dehumidifier will re-start when the tank is restored in its correct position.

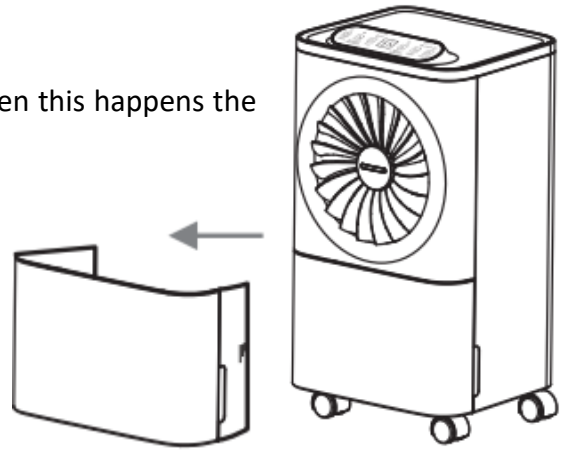

NOTES:

When you remove the water tank, do not touch sensors or any parts which are situated behind tank. Doing so may damage the product. Be sure to push the tank gently all the way into the unit. Banging the bucket against anything or failing to push it in securely into place may cause the unit not to operate. Do not remove any parts from the water tank or tank enclosure. The water full sensor will no longer be able to detect the water level correctly and water may leak from the water tank.

CONTINUOUS DRAINAGE

Water can be automatically plumbed in or drained into a sink, a larger recipient or through the wall into an outside drain by attaching a pipe to the unit (9 mm internal diameter). A 1.5m pipe is supplied, although longer pipes can be used. Insert the pipe into the drain outlet at the back of the unit as shown here.

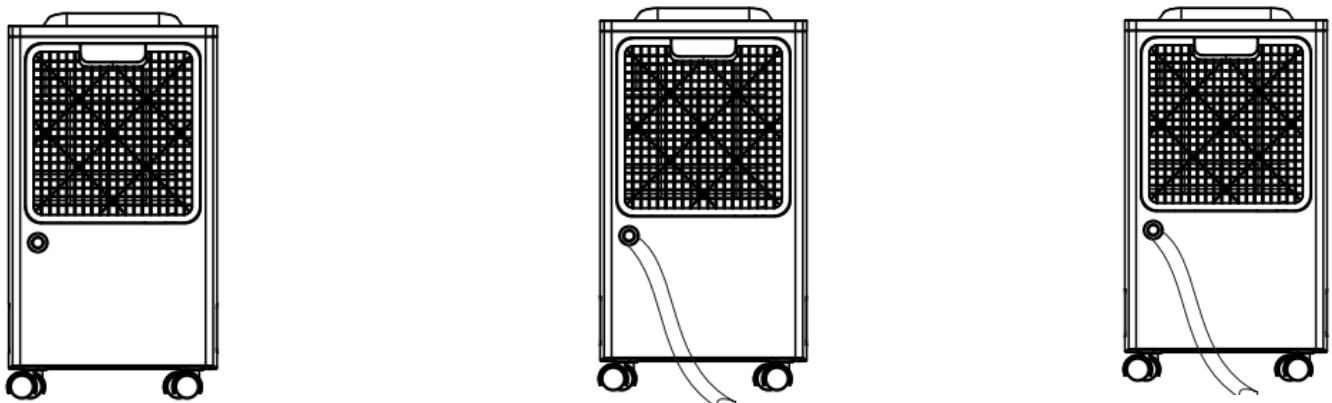

Make sure the connection between pipe and the drain outlet is tight and does not leak. Then direct the pipe to a suitable drainage point. This unit uses gravity to dispose of water hence the drain should be lower than the water outlet on the unit. Put the tank back. Be sure to run the water pipe downward and let the water to flow out smoothly. Do not kink or bend the pipe.

The permanent drain can be used in conjunction with an external water pump (e.g. when draining from a cellar) to lift the water upwards.

CARE AND MAINTENANCE

Always shut off the unit and unplug from the mains before cleaning or performing any maintenance. When it is not in use for long periods it is advisable to remove the plug from the power socket. Do not use chemical solvents (such as benzene, alcohol or gasoline) as they may cause irreversible damage to the unit.

1. CLEAN THE GRILLE AND CASE

Use water and a mild detergent to clean the washable filter frame. Do not use bleach or abrasives. Do not splash water directly onto the main unit. Doing so may cause an electric shock and can lead to the insulation to deteriorate, or cause the unit to rust. The air intake and outlet grilles get soiled easily, so use a vacuum attachment or soft brush to clean. Wipe the dehumidifier body with a soft damp cloth or kitchen towel.

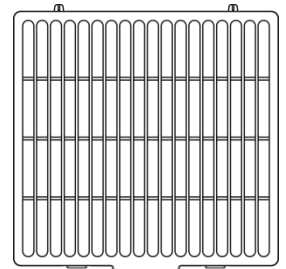

Remove the filter frame. If the optional carbon filters are fitted, remove them from the frame and Hoover gently approximately every 2-3 weeks.

If the mesh filter is dirty Hoover it, if it is heavily soiled wash it with warm soapy water and dry thoroughly before reinserting it in the unit.

When filter cleaning is finished and filters are dry place them back into the unit.

NOTE: While the carbon and HEPA filters is optional, never run the unit without the filter frame correctly inserted.

2. CLEAN THE WATER TANK

Every few weeks, clean the tank to prevent growth of mould, mildew and bacteria. Partially fill the tank with clean water and add a little mild detergent. Swish it around and then empty the tank and rinse.

NOTE: Do not use a dishwasher to clean the tank. After cleaning and drying, the tank must be reinserted securely into dehumidifier in order to restart operation.

END OF SEASON MAINTENANCE

1. Run the unit for at least 30 minutes with the desired humidity set to max, this will allow the unit to internally dry.
2. After 30 minutes, empty and clean the water tank, ensuring it is fully dry before reinserting into the unit.
3. Clean the unit and the filters as per cleaning procedure above.
4. Coil the power cord on the special cord storage rest at the back of the unit
5. Cover the unit and keep it in a dry place.

FREQUENTLY ASKED QUESTIONS

Why doesn't the dehumidifier seem to extract much water if the temperature is low?

This is a compressor dehumidifier which works best in temperatures above 15°C. If the temperature is low and the air is dryer than the setting on the humidistat the unit will not extract water. If you want to use a dehumidifier for outside buildings, unheated properties, boats or garages please check our desiccant range.

Why doesn't the unit work /or stops suddenly?

The water tank may be full or displaced. To rectify: empty the tank and carefully place the tank back in the unit. Also the unit may be running in dehumidifying mode with a low room temperature. Please check if the room temperature is lower than 5°C. If so, the unit will stop working while in dehumidifying mode. (unit may be defrosting).

The ambient operating range is between 5°C and 35°C with a relative humidity ranging from 35% to 80%. For maximum efficiency use the unit between 15°C and 32°C.

Sometimes cold and/or hot air comes out from the air outlet grill, why?

When the unit is in dehumidifying mode it absorbs humid air from room and freezes it to reduce the humidity. During the cold cycle there should be cold air coming out of the unit. During the hot cycle hot dry air should be coming out of the outlet grill.

TROUBLESHOOTING

Issue	Cause	Solution
Hot or cold air being produced	Normal Operation	When the unit is in dehumidifying mode it absorbs humid air from room and freezes it to reduce the humidity. During the cold cycle there should be cold air coming out of the unit During the defrost cycle hot dry air should be coming out of the outlet grill.
Unit does not operate	Is the plug properly inserted in the socket?	Insert the plug into the socket and turn the switch on.
	Is E2 displayed on the control panel	Tank full, float displaced or tank not properly inserted. Empty tank, check float and make sure tank is properly inserted in unit.
Dehumidifier does not extract water	Is the unit set to a humidity level lower than the one in the room?	Set the humidity level on the humidistat bellow current humidity reading.
	Is the temperature too low for water extraction to be efficient?	Increase temperature in the room or reposition the unit.
	Is any intake grill or discharge blocked? Is the unit too close to walls.	Remove obstructions and restart the unit. Ensure a distance of at least 20 [cm between the unit & walls
Airflow seems weak	Is filter dirty or clogged?	Please service the filters regularly as per user manual.
Unit is noisy during operation	Is the unit on an uneven surface?	Please place on flat horizontal surface.
	Is filter clogged?	Please service the filters regularly as per user manual.
E2 Error Code	Water tank is full	Tank full, float displaced or tank not properly inserted. Empty tank, check float and make sure tank is properly inserted in unit.
Any other malfunctions will need to be reported to electriQ service centre. Do not attempt unauthorised repairs as these may invalidate the warranty.		

TECHNICAL DATA

Model	CD10L-V5
Voltage	220-240V ~ 50Hz
Dehumidifying capacity	10L / day (at 30° C / 80%RH)
Fan Speeds	2
Power Consumption	240W
Running Amps	1.3 Amps
Tank Capacity	2.4 litres
Desired Humidity Range	35 – 80%
IP Rating	IPX1
High / Low Pressure	3.2/0.7MPa
Filters	Carbon (Optional)
Dimensions mm (WxDxH)	260x220x480(mm)
Weight (Kgs)	9
Refrigerant	R290, 50 grams
GWP	3
  	

Disposal: Do not dispose this product as unsorted waste. Collection of such waste must be handled separately as special treatment is necessary.

Recycling facilities are now available for all customers at which you can deposit your old electrical products. Customers will be able to take any old electrical equipment to participating sites run by their local councils. Please remember that this equipment will be further handled during the recycling process, so please be considerate when depositing your equipment. Please contact the local council for details of your local household waste recycling centres.



electriQ UK SUPPORT

www.electriQ.co.uk/support

Please, for your own convenience, make these simple checks before calling the service line.

1. Has the unit been standing upright for at least 2 hours?
2. Is the unit plugged into the mains?
3. Is the fuse OK?
4. Switch the unit off and wait three minutes to see if the issue is resolved. Restart the unit.
5. Check if the water tank is full.
6. Was the troubleshooting guide followed?

If the unit still fails to operate call: 0330 390 3061 or complete the online form

Office hours: 9AM - 5PM Monday to Friday

Unit J6, Lowfields Business Park,
Lowfields Way, Elland
West Yorkshire, HX5 9DA